



# PHANTOM KT1610 KT1210

HIGH-SPEED CAMERAS

1280 x 832 up to 15,640 fps (KT1610),  
up to 12,090 fps (KT1210)  
BSI sensor architecture

## FEATURES & BENEFITS

### SMALL SIZE, BIG PERFORMANCE

- Increased throughput capacity in a compact platform (12.5 X 12.5 X 16.3 cm) benefits stereo imaging applications by reducing overall system size and complexity
- Lightweight (3.2 kg) with mounting points on 4 sides and a removable handle makes installation simple

### ADVANCED SOLUTIONS FOR MOTION ANALYSIS

- 1280 x 832 Back-side Illuminated (BSI) sensor ensures superior image performance due to increased pixel response
- Programmable I/O for advanced signals control, synchronization and precision triggering
- Binned mode combines pixels for increased vertical resolution at the highest frame rates
- Reduce motion blur with exposure times down to 190 ns with Fast Option, independent of frame rate

### WORKFLOW FLEXIBILITY

- Use 10Gb Ethernet for 7X faster data download directly from the camera's RAM buffer, up to 128 GB
- CF Express cards, SDI/HDMI video out and on-camera controls enable a secure and efficient untethered workflow

## IMAGE & SENSITIVITY

Sensor Type	CMOS, Back Side Illuminated (BSI) with Global Shutter	
Maximum Resolution	1280 x 832	Binned 640 x 384
CAR Increments	256 x 32	Binned 128 x 64
Pixel Size (µm)	18.5	Binned 37.0
Sensor Size (mm)	23.7 x 15.4	
Bit Depth (ADCs)	12 bit	
	<b>EMVA 1288 Measurements (at 533 nm)</b>	
	<b>Standard Mode</b>	<b>Binned Mode</b>
Quantum Efficiency (%)	84.6% mono 77.0% color	83.0%
Max. SNR (dB)	39.9	45.8
Absolute Sensitivity Threshold (e <sup>-</sup> )	23.9 mono 26.6 color	56.3
Saturation Capacity (e <sup>-</sup> )	9,675 mono 9,968 color	37,882
Temporal Dark Noise (e <sup>-</sup> )	23.4	55.8
Dynamic Range (dB)	52.2	56.5

- Reported measurements were taken at 533 nm with both monochrome and color cameras, using the EMVA 1288 4.0 standard

- Visit: [www.phantomhighspeed.com/emva](http://www.phantomhighspeed.com/emva) for more information on EMVA 1288



Back Panel

## SPECTRAL RESPONSE

### Quantum Efficiency Monochrome and Color

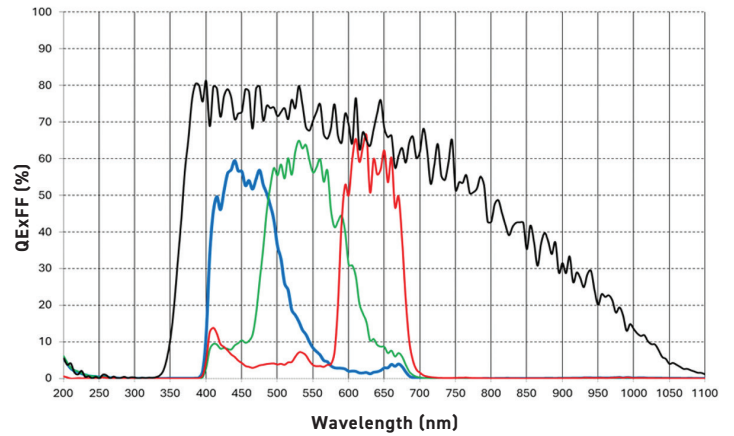

## CONNECTIVITY & SIGNALS

Ethernet	Gigabit and 10Gb Ethernet (standard)
Timecode	IRIG-B Modulated and Un-modulated
Rear Port Descriptions	Ethernet - Fischer 8-pin Power 20-28V - Fischer 6-pin RDIO Range data + 2 Programmable I/O - Fischer 8-pin 3 Dedicated BNCs for Trigger, Timecode-in and SDI Video 1 Dedicated BNC for Programmable I/O
Programmable I/O Signals	(3 ports) for Strobe, Fsync, Ready, Timecode Out, Multi-Strobe, Auto Trigger (+mode 2), SW Trigger, Recording, Event In, Memory Gate In, Pretrigger In, Auxtrigger In, Range Data Corr. Assign and define signals in PCC
Hardware Trigger	TTL (falling or rising edge), or High-Voltage (falling or rising edge). Dedicated BNC
Software Trigger	Trigger button; via Ethernet; via Image-based auto trigger (IBAT), via SDK command or telnet
Synchronization	External Sync (5V TTL) via Fsync or IRIG-B Timecode
Recording Features	External frame rate control, burst mode, continuous recording, multi-partitions, frame straddling
Video Output	3G-SDI via BNC (rear), Din and HDMI (front)
Accessory Power	4-pin Hirose (front) for 12V monitors up to 1 Amp



MEMORY & STORAGE		
RAM Buffer	32GB, 64GB, 128GB RAM options	
Capture Duration**	KT1610: 32GB = 1.3s; 64GB = 2.6s; 128GB = 5.2s	KT1210: 32GB = 1.7s; 64GB = 3.4s; 128GB = 6.8s
Multi-Cine	Up-to 63 Partitions	
Non-Volatile Media	CF Express type B Approved cards at launch: Exascend 1TB Essential Series and Pro; Wise Advanced 1TB	
Media Transfer Rates	275 MB/s Full 32GB RAM save time = 2 minutes	

FRAME RATES & EXPOSURE		
Top FPS at Max Resolution	KT1610: 15,640	KT1210: 12,090
Maximum FPS	KT1610: 687,500 std, 916,660 w/ FAST option* KT1610-E225 225,000	KT1210: 687,500 std, 708,330 w/ FAST option* KT1210-E225 225,000
Minimum FPS	100	
Frame Timer Clock	110 MHz	
Minimum Exposure	1.06 µs standard; 190 ns with FAST Option*	
PIV Features	Shutter-off mode with a straddle time of 274 ns (effective frame pair frequency of 3.64 MHz for frame straddling PIV)	
Exposure Features	Burst Mode; EDR (Extreme Dynamic Range); Auto-Exposure, Overexposure indication over video and in PCC	

## FRAME RATE CHART

Table provides examples of common resolutions and the maximum frame rate.

MAXIMUM FRAME RATE - FPS				
Resolution (H x V)	KT1610		KT1210	
	Standard	Binned Mono Output Only	Standard	Binned Mono Output Only
1280 x 832	15,640	-	12,090	-
1280 x 800	16,270	-	12,570	-
1280 x 480	27,090	-	20,930	-
768 x 768	27,700	-	21,410	-
1280 x 320	40,590	-	31,360	-
768 x 384	55,270	-	42,700	-
512 x 512	62,140	-	48,020	-
768 x 192	110,000	-	85,000	-
768 x 96	220,000	-	170,000	-
512 x 32	687,500 (916,660 w/ FAST)	-	687,500 (708,330 w/ FAST)	-
640 x 384	-	67,480	-	52,140
384 x 384	-	110,000	-	85,000
640 x 192	-	134,140	-	103,650
512 x 128	-	244,440	-	188,880
256 x 128	-	478,260	-	369,560
384 x 64	-	647,050	-	500,000
256 x 64	-	687,500 (916,660 w/ FAST)	-	687,500 (708,330 w/ FAST)

\* Certain Phantom cameras are held to export licensing standards. Details available at: [www.phantomhighspeed.com/export](http://www.phantomhighspeed.com/export)

\*\* Record times shown are with the top FPS at max resolution

\*\*\*KT1610-E225 and KT1210-E225 maximum frame rate is 225,000 fps

## CONTROL

Software & OS	Phantom PCC (Windows x64); SDK available for C/C++, C#, Python, MatLab and LabView
On-Camera Controls	Standard Feature. Access menu system with encoder, viewed on video monitor. Buttons for trigger, play and save - Color indicates current camera state.
Primary File Format	Phantom Cine RAW (.cine)
Alternative File Formats	Easily convert to formats including .mp4, Apple ProRes .mov, .avi, Tiff, JPG, DNG and many more using PCC. Cine files are directly compatible with many major video editing and motion analysis programs.
Software Features	Continuous Recording for automated workflows, Integrated Data Acquisition (NI-DAQ), support for DIC Calibration with Sync-Snapshot menu, automatic file naming, advanced Image Tools including Crop & Resample, Tone Curves, Filters and more.

## MECHANICAL

Housing Variants	N/A
Size	4.9 x 4.9 x 6.4 in (125 x 125 x 163 mm); handle adds 1.9 in (48 mm)
Weight	7 lbs (3.2 kg)
Lens Mounts	F-Mount standard (aperture support for Nikon G-style lenses). Also available: Canon EF (with electronic focus and iris control), PL, C and M42. Mounts are easily interchangeable and can be removed to integrate with different optics.
Mounting Points	Standard 1/4x20 and 3/8" mounting points on bottom, with 1/4x20 and M5 mounting points on each side.
Internal Shutter	Standard, for remote black references
Cooling	Active cooling. Quiet mode disables fans during capture.

## POWER

AC Power	100-240 VAC, 160W power supply included
Voltage Range	20-28V
Power Consumption	90W typical
Battery Options	Works with 24V battery sources only, input through primary power port

## ENVIRONMENTAL

Operating Temperature	-10 to +50°C
Storage Temperature	-20 to +70°C
Operating Humidity	≤85% RH, non-condensing
Operational Shock	30G, 11msec sawtooth, 3 axes, 2 directions per axis, 10 shocks per direction (60 pulses total)
Operational Vibration	7.5 Grms, 50Hz-2KHz, 3 axes, 15 min/axis, IAW MIL-STD-202H Method 214-I, Test Condition B
Regulatory	<b>Made in the USA</b> <b>Emissions</b> - CE Compliant EN 61326-1, Class A <b>Immunity</b> - CE Compliant EN 61326-1, Class A <b>FCC</b> - CFR 47, Part 15, Subpart B & ICES-0003, Class A <b>Safety</b> - IEC 62368-1

## SERVICES AND SUPPORT NETWORK

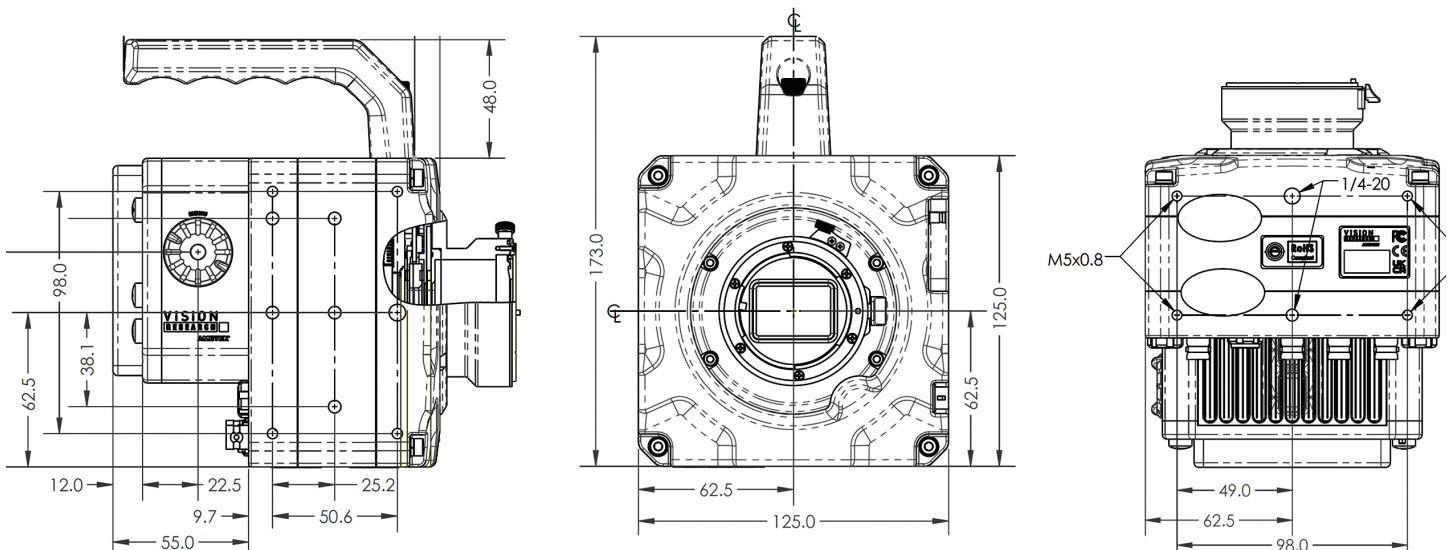

Phantom cameras are supported by Vision Research's Global Service and Support network, providing PhantomCare services from multiple sites around the globe.

Contact us about training courses and application services applying both simple and advanced high-speed scientific imaging techniques.





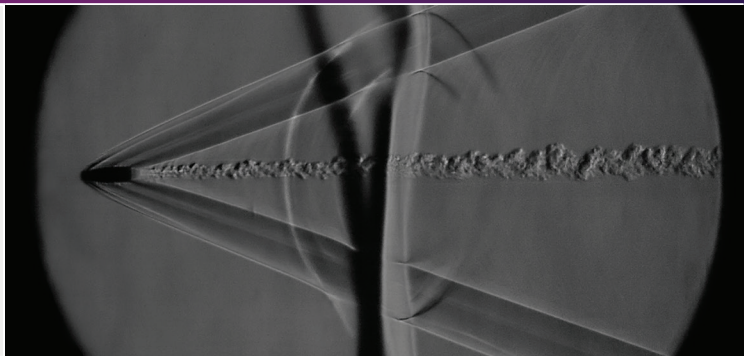
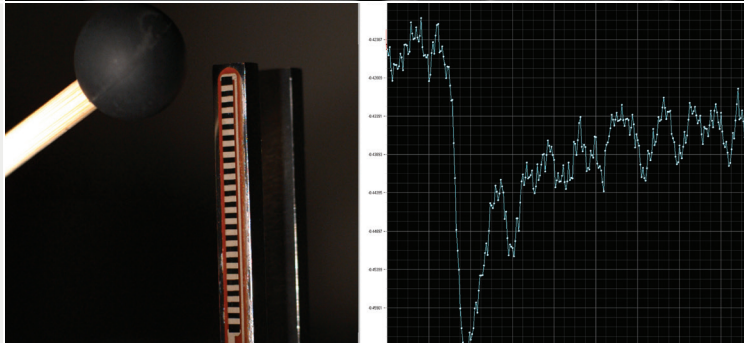
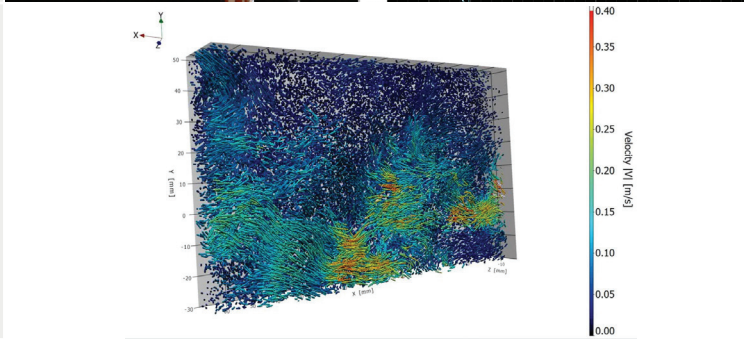
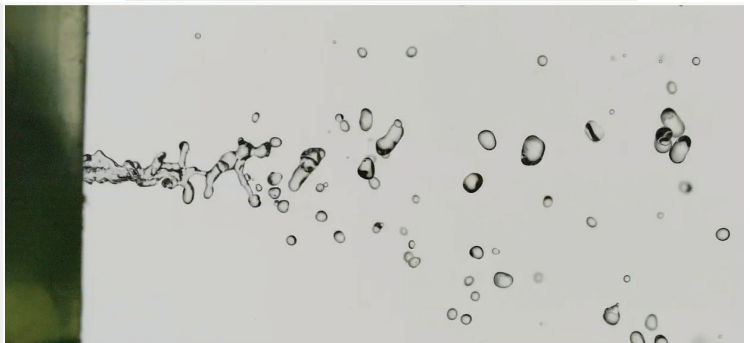

### APPLICATION-SPECIFIC FEATURES

<p><b>Ballistics &amp; Range</b></p>	<p>With frame rates up to 916,660 fps (KT1610 with FAST option), KT 1Mpx cameras are an ideal choice for ballistic studies and shockwave analysis.</p> <p>Dynamic range of <b>52.2 dB</b> enables the characterization of extremely luminous events, coupled with the EDR feature to further extend dynamic range when needed.</p> <p>High fidelity triggering and synchronization are ideal for easily and accurately capturing weapon body mechanics, muzzle shots, projectile flight and impacts. IRIG-B is used to share a common time code between connected high-speed data-collection systems.</p>	
<p><b>Data Fusion</b></p>	<p>Precision TTL inputs and outputs enable synchronization with external data acquisition systems. Natively compatible with select list of National Instruments DAQ units.</p> <p>Range Data feeds the camera digital data during the recording, and gets included with Cine raw files. A graphic interface is included in Phantom camera control software for plotting DAQ data and tracked points. Utilize the built-in report features to visualize external data and images together.</p>	
<p><b>Particle Image Velocimetry</b></p>	<p>Designed for ease of integration into pulse laser systems, KT-series cameras are capable of direct integration into complex PIV-setups (both time-resolved and frame straddling). With a straddle time of <b>230 ns</b>, resolution of frame pairs can be down to <b>4.34 MHz</b>.</p> <p>Natively exports .CINE raw files and .tiff stacks for importing into any PIV software, commercial and open source.</p> <p>Avoid the need for complicated external timing boxes with the built-in programmable IO with delay, inversion, filtering and pulse width controller.</p>	
<p><b>Spray Dynamics</b></p>	<p>High-speed frame rates up to 916,660 fps (KT1610 with Fast) and exposure time down to <b>190 ns</b> enable sharp analysis of spray patterns in a wide range of industrial, automotive and medical imaging.</p> <p>The 1280 x 832 widescreen sensor format gains speed when windowing vertically, ideal for maximizing pixel resolution in the direction of the spray pattern.</p> <p>QExFF rating above <b>80%</b> and AST of <b>23.9</b> results in the sensor response necessary to reduce motion blur, ensuring crisp edges for accurate measurements.</p>	
<p><b>Timing Accuracy</b></p>	<p>With a base clock of <b>110 MHz</b>, the timing granularity of the clock is <b>9 ns</b> with sync and timing accuracy down to 1 clock cycle. Timing validation data for fps, exposure and sync via high-speed LED-clock available by Vision Research team.</p>	

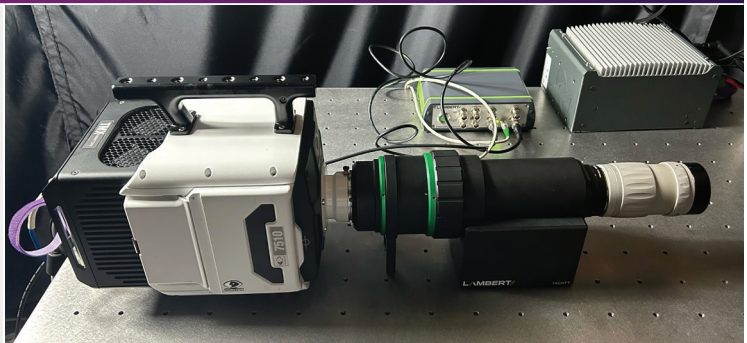
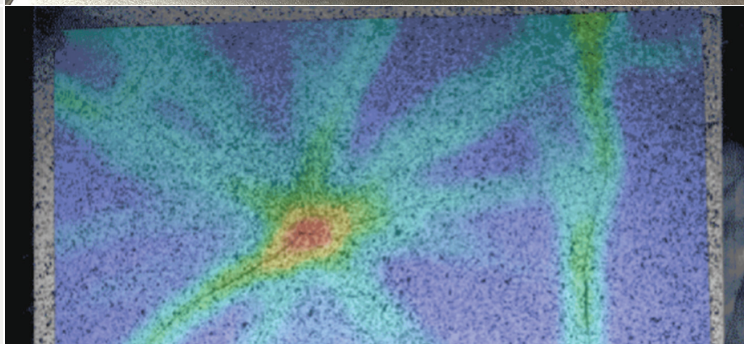
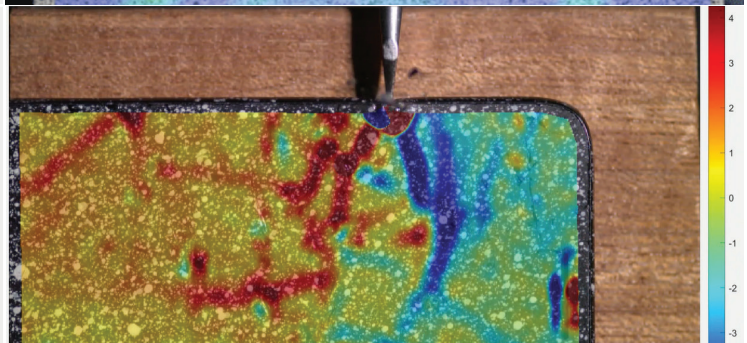
**APPLICATION-SPECIFIC FEATURES**

<p>Low-light Tests</p>	<p>With a read noise of <b>23.4 e-</b> and absolute sensitivity threshold (AST) of <b>23.9 e-</b>, this sensor can pick up ultra-small signals generated by fluorescence experiments, screen inspections, scintillators, bioluminescent events or any challenging light starved application.</p>	
<p>Digital Image Correlation</p>	<p>The combination of spatial resolution and low sensor noise (AST) of <b>23.4 e-</b> permits the capability of measuring ultra-low strain floors, extraction of low-amplitude vibrational modes and displacements.</p> <p>The camera system natively exports .CINE and .tiff stacks for importing into any DIC software, commercial and open source.</p>	
<p>3D Motion Analysis</p>	<p>The compact and lightweight <b>3.2 kg</b> design enables close camera positioning for 3D image capture as used in product reliability testing systems, shrinking the size and complexity of support equipment.</p> <p>Synchronization for multiple cameras is precise with timing accuracy of <b>9 ns</b>, and straight forward to configure with the camera's built-in Programmable I/O interface.</p>	
<p>OEM Integrability</p>	<p>Camera is designed to be completely integrated into larger systems, from both software (via <b>SDK</b>) and hardware. Can be mount ready for integrating into microscopes, intensifiers, spectrometers, X-ray systems, flight followers and/or schlieren systems.</p> <p>Hardware signals are available for complete external camera control.</p>	

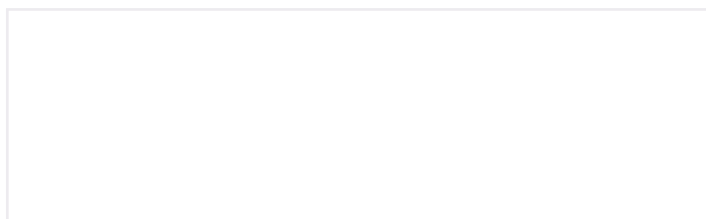
**ABOUT VISION RESEARCH**

Focused. Since 1950, Vision Research has been designing, and manufacturing high-speed cameras. Our single focus is to invent, build, and support the most advanced cameras possible.



100 Dey Road  
Wayne, NJ 07470 USA  
+1.973.696.4500